



## ABBATTITORI DI TEMPERATURA

/ blast chillers

2021



**BEHIND  
THE  
FRESH-  
NESS**

**INDICE**  
*table of contents*

<b>IL MONDO POLARIS</b> <i>the Polaris world</i>	<b>5</b>
<b>ABBATTITORI PENSATI PER OGNI PALATO</b> <i>chillers designed for every palate</i>	<b>6</b>
<b>CARATTERISTICHE E VANTAGGI</b> <i>features and benefits</i>	<b>10</b>
<b>ABBATTITORI MONOSCOCCA LINEA JUMPY</b> <i>Jumpy monocoque chillers</i>	<b>22</b>
<b>ABBATTITORI MONOSCOCCA LINEA ECO</b> <i>Eco monocoque chillers</i>	<b>24</b>
<b>ABBATTITORI MONOSCOCCA LINEA KEEP</b> <i>Keep monocoque chillers</i>	<b>34</b>
<b>ABBATTITORI MONOSCOCCA LINEA GENIUS</b> <i>Genius monocoque chillers</i>	<b>38</b>
<b>TABELLA RIASSUNTIVA ABBATTITORI MONOSCOCCA</b> <i>monocoque chillers summary table</i>	<b>48</b>
<b>ABBATTITORI A CARRELLO LINEA GENIUS</b> <i>Genius trolley chillers</i>	<b>50</b>
<b>TABELLA RIASSUNTIVA ABBATTITORI A CARRELLO</b> <i>trolley chillers summary table</i>	<b>62</b>
<i>/ blast chillers</i>	<b>3</b>



Dietro la freschezza dei tuoi prodotti, trovi da più di 30 anni la **tecnologia del freddo Polaris**. Un interlocutore in grado di interpretare l'evoluzione dei tuoi bisogni nel mondo del freddo e di accompagnarti professionalmente nelle **sfide quotidiane**. Ad oggi Polaris presenta una gamma articolata in grado di coprire i **principali settori alimentari** di prodotto:

-  GASTRONOMIA
-  GELATERIA
-  PIZZERIA
-  PASTICCERIA
-  PANETTERIA

Gli abbattitori Polaris vantano una **trasversalità di utilizzo** che li rende adatti a qualsiasi **prodotto alimentare**.

<b>PRODOTTI A NORMA EN17032</b>	+65° ➔ +10° / 120 min
	+65° ➔ -18° / 270 min

*Behind the freshness of your products, for more than 30 years is the **Polaris cold technology**. An interlocutor able to interpret the evolution of your needs in the world of cold and accompany you professionally in **daily challenges**.*

To date, Polaris has an articulated range able to cover the **main food product sectors**:

-  gastronomy
-  ice cream
-  pizzeria
-  confectionery
-  bakery

The Polaris chillers boast a **transversal use** that makes them suitable for any food product.

<b>PRODUCTS ACCORDING TO EN17032</b>	+65° ➔ +10° / 120 min
	+65° ➔ -18° / 270 min



# ABBATTITORI PENSATI PER OGNI PALATO

chillers designed for every palate

Fulcro attorno al quale sviluppare il tuo lavoro, l'abbattitore di temperatura è oggi un partner imprescindibile, in grado di garantirti un **miglioramento effettivo** del livello qualitativo, quantitativo ed economico della tua impresa.

*Fulcrum around which to develop your work, the blast chiller is today an indispensable partner, able to ensure an **effective improvement** of the qualitative, quantitative and economic level of your business.*

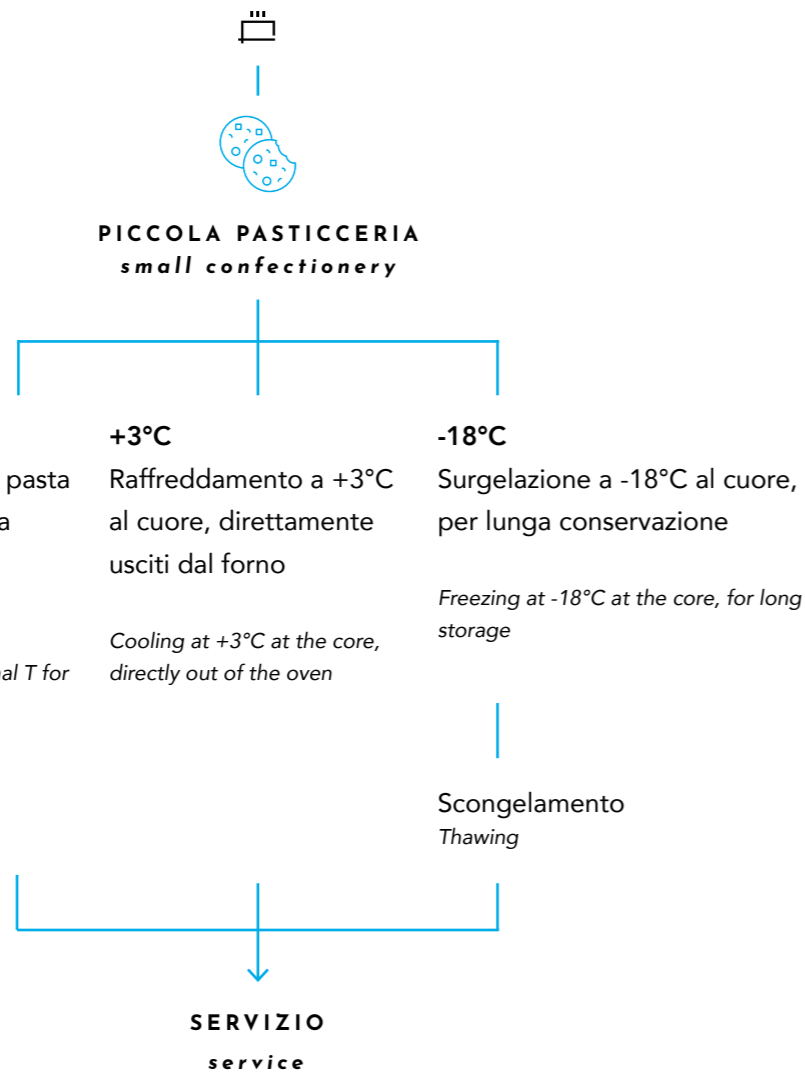

Il gelato esce dalla macchina attorno ai -7°C, l'abbattitore porta il prodotto a -12°C creando una pellicola sulla superficie (detto **abbattimento in crosta**). Questo sistema permette di evitare la **perdita di volume** e la **creazione di macrocristalli** particolarmente dannosi per la struttura e la qualità del gelato.

*The ice cream leaves the machine at around -7°C, the chiller brings the product to -12°C, creating a film on the surface (called **crusting**). This system prevents the **loss of volume** and the **creation of macro-crystals** that are particularly harmful to the structure and quality of the ice cream.*

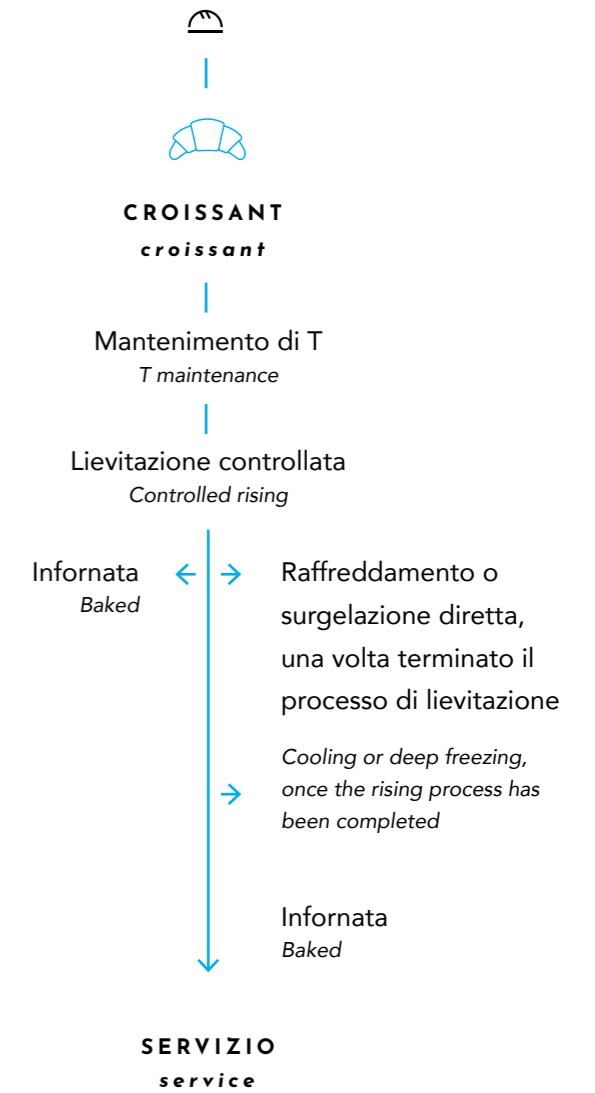

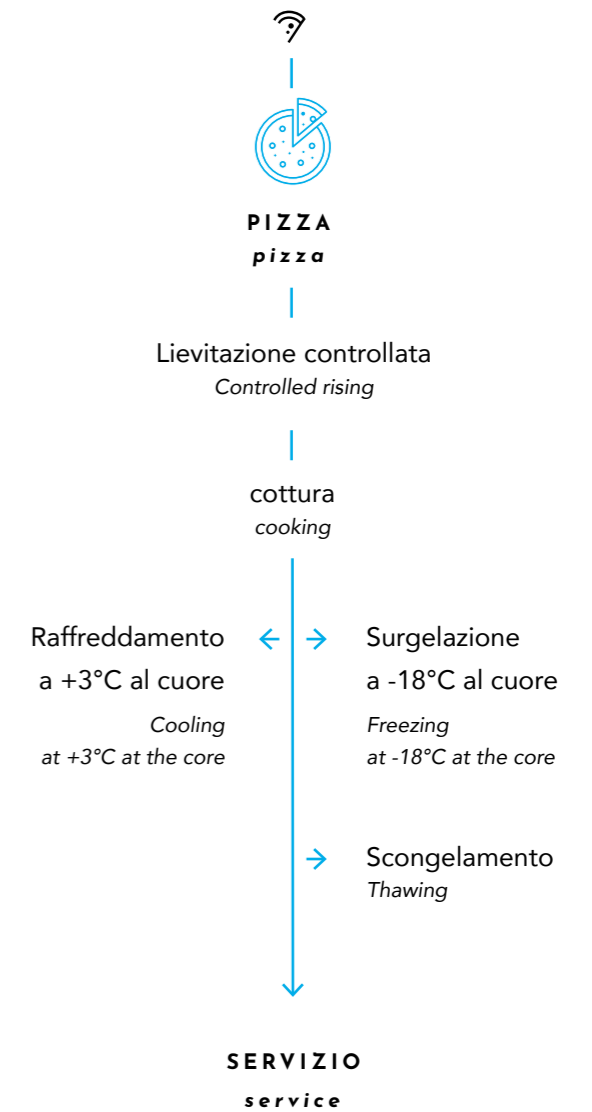
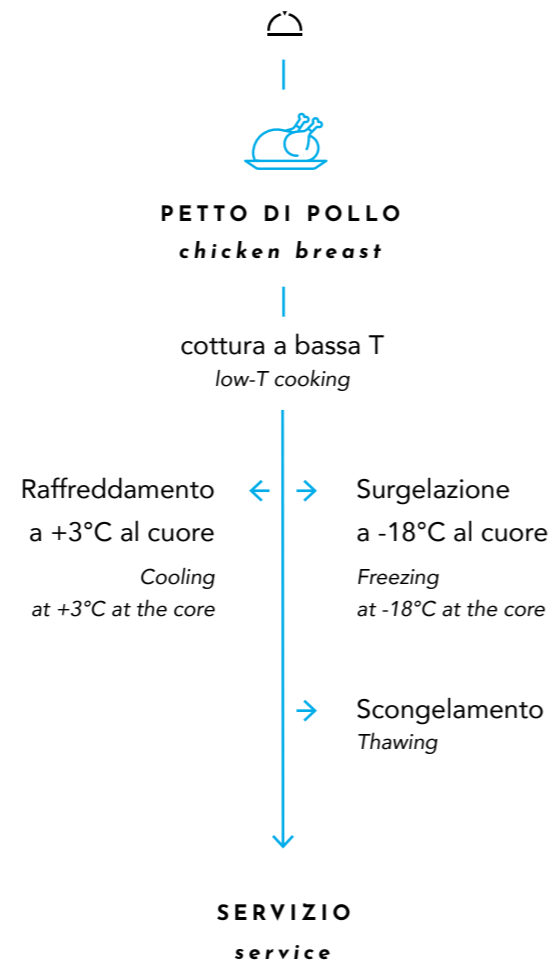

## COS'È UN ABBATTITORE DI TEMPERATURA?

Un abbattitore è uno strumento dinamico di raffreddamento, in grado di abbassare velocemente la temperatura all'interno della camera, consentendo un **blocco repentino dell'invecchiamento** del tuo prodotto.

Grazie alla nostra consolidata esperienza e all'innovativa tecnologia Polaris, oggi possiamo **accompagnarti nella scelta del prodotto più adatto alle tue esigenze**, permettendoti di toccare con mano la qualità Polaris.

### Perché abbattere?

per due ragioni principali:

**1** INCREMENTO DI QUALITÀ

**2** RISPARMIO



## What is a blast chiller?

A chiller is a dynamic cooling instrument, able to quickly lower the temperature inside the chamber, allowing a **sudden stop of the ageing** of your product.

Thanks to our consolidated experience and innovative Polaris technology, today we can **accompany you in choosing the product that best suits your needs**, allowing you to touch with hand the Polaris quality.

### Why chill?

for two main reasons:

**1** quality increase

**2** saving





# CARATTERISTICHE DEL PRODOTTO INALTERATE NEL TEMPO

## 1 INCREMENTO DI QUALITÀ

*quality increase*

*product features unaltered over time*

### COME?

La tecnologia Polaris permette di raffreddare (+3°C) o surgelare (-18°C) bloccando sul nascere tutti i possibili **fattori degenerativi del prodotto** quali carica batterica, ossidazione, sovracottura e calo peso, responsabili del fisiologico degrado del prodotto alimentare.

### how?

*The Polaris technology allows to cool (+3°C) or freeze (-18°C), blocking all potential **degenerative factors of the product**, such as bacterial load, oxidation, overcooking and weight drop, responsible for the physiological degradation of the food product.*



### MIGLIORIAMO LA SICUREZZA DEI TUOI ALIMENTI

Rallentando o bloccando il ciclo degenerativo ti permette di mantenere **inalterate le proprietà** dei tuoi alimenti per una **conservazione ottimale** nel tempo.

*we improve the safety of your foods*

*Slowing or blocking the degenerative cycle allows you to maintain **the properties of your food unaltered** for **optimal storage** over time.*



### COSTANTE QUALITÀ

Ti dà la possibilità di generare maggior produzione in totale sicurezza, garantendo una **linearità di qualità** per un fabbisogno temporale **molto più ampio**.

*constant quality*

*It provides you the option to safely generate more production, ensuring a **linear quality** for a **much wider** time requirement.*



### VELOCITÀ DI SERVIZIO

Organizzazione e **prodotto sempre disponibile**, ti dà modo di rispondere velocemente alle richieste, dando una **qualità di servizio ineccepibile**.

*speed of service*

*Organisation and **product always available**, gives you the opportunity to quickly meet requests, giving an **impeccable quality fo service**.*



### ALLUNGHIAMO LA VITA DEI TUOI PRODOTTI

Con il raffreddamento o surgelazione Polaris, i tuoi alimenti possono essere **conservati molto più a lungo**, dandoti sempre la possibilità di far fronte alle fasi altalenanti della domanda.

*we extend the life of your products*

*With Polaris cooling or freezing, your food can be **stored much longer**, always giving you the opportunity to cope with the varying phases of the demand.*





Mantenere intatte le proprietà dei prodotti nel tempo ti permetterà di **risparmiare economicamente** in maniera significativa, per esempio potrai:

*Keeping the product properties intact over time allows you to significantly **save money**, for example you will be able to:*

# 2

**RISPARMIO**  
*saving*

*economic  
increase in  
every  
process*



#### MIGLIORARE L'ORGANIZZAZIONE NEI PROCESSI PRODUTTIVI

Sarà possibile produrre **più quantità in una volta sola**, garantendo una costanza di risultato, un'ottimizzazione del tuo tempo e la possibilità di concentrarti sullo svolgimento di altre attività.

*improve organisation  
in the production processes*

*It will be possible to produce **larger quantities at once**, ensuring consistency of result, optimisation of your time and the option to concentrate on carrying out other activities.*



#### RIDURRE GLI SCARTI

Ti permetterà di utilizzare **solo quello di cui hai bisogno** e di **conservare il rimanente** evitando il rischio di produrre troppo o troppo poco e di dover buttare ciò che non vendi nel giro di pochi giorni.

*reduce  
waste*

*It will allow you to use **only what you need** and **keep the remainder** avoiding the risk of producing too much or too little and have to throw away what you do not sell in a few days.*

# INCREMENTO ECONOMICO IN OGNI PROCESSO



#### OTTIMIZZARE GLI ACQUISTI

Potrai acquistare, in quantità più elevate, i prodotti di stagione garantendo un **utilizzo pianificato nel tempo** ad un prezzo decisamente conveniente (questo è solo uno dei tanti piccoli segreti che ti aiuteranno a risparmiare).

*optimise  
purchases*

*You can purchase seasonal products in larger quantities, ensuring a **planned use over time** at a very affordable price (this is only one of the many small secrets that will help you save money).*

A fine anno l'insieme di queste poche voci possono risultare estremamente rilevanti nel **conto economico** dell'impresa.



#### FARE FRONTE AI PICCHI DI DOMANDA

Garantirai ai tuoi clienti una **velocità di servizio sempre ottimale**, senza rischiare delle mancate vendite a causa di scarsità di prodotto.

*meet the demand  
peaks*

*You will assure your customers an **always optimal speed of service**, without risking the lack of sales due to lack of product.*

*At the end of the year, these few items can be extremely significant in the company's **income statement**.*

# +3°C

# -18°C

## TEMPERATURA DI RAFFREDDAMENTO (+3°C)

L'utilizzo dell'abbattitore termico in conservazione (+3°C) permette di **raffreddare velocemente i prodotti**, superando rapidamente la soglia di temperatura ambiente, dove si ha la maggior proliferazione batterica (+65°C +10°C circa), garantendo un'**integrità totale del prodotto**, una riduzione di dispersione dei liquidi responsabili della disidratazione e del deperimento del prodotto nel tempo, oltre che del calo peso e della sovracottura.

## cooling temperature (+3°C)

Use of the thermal chiller in storage (+3°C) allows to **quickly cool products**, rapidly exceeding the room temperature threshold, where there is the greatest bacterial proliferation (approx. +65°C +10°C), ensuring **total product integrity**, reduction in the dispersion of liquids responsible for product dehydration and deterioration over time, as well as weight loss and overcooking.

## TEMPERATURA DI SURGELAZIONE (-18°C)

L'utilizzo dell'abbattitore termico in surgelazione (-18°C) permette di rendere inerte il prodotto in un lasso di tempo estremamente ridotto e di evitare la **fuoriuscita di liquidi** e la conseguente **creazione di macrocristalli** responsabili della peggiorata qualità del prodotto una volta scongelato.

## freezing temperature (-18°C)

The use of the thermal chiller in freezing (-18°C) makes the product inert in an extremely reduced period of time and avoids the **leakage of liquids** and consequent **creation of macro-crystals** responsible for the deteriorated quality of the product once defrosted.

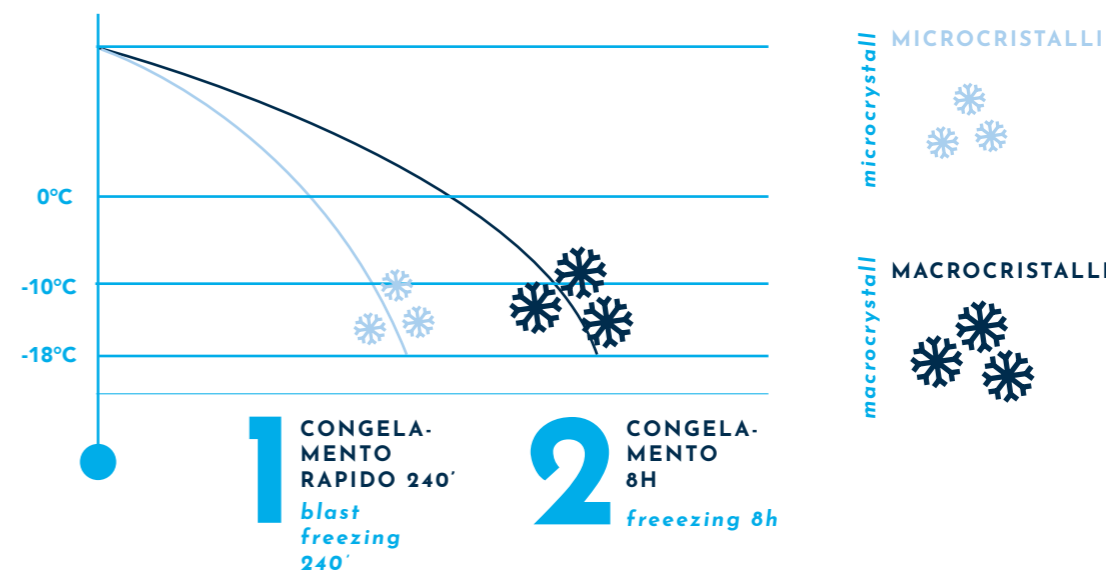
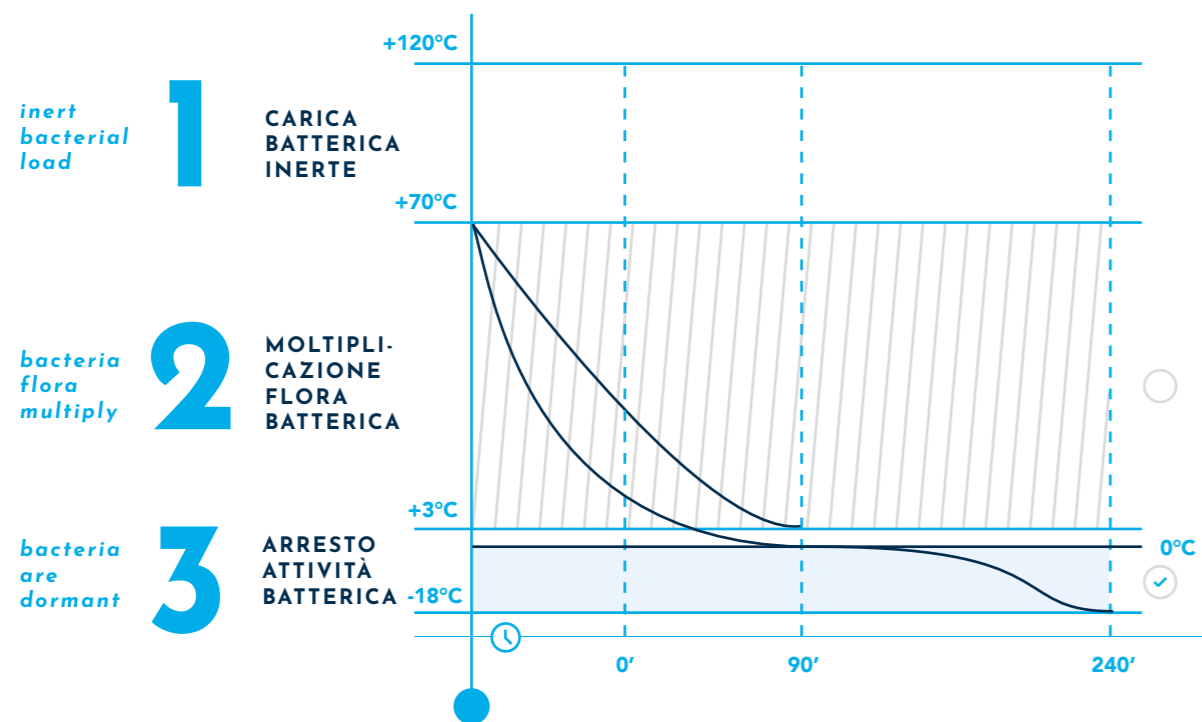

Formazione di macrocristalli di ghiaccio che causano la rottura della membrana intercellulare con successiva perdita di liquidi e vitamine dei cibi.

Large-sized ice crystals form in the spaces between cells and cause cell membrane to break, which in turn leads to a loss of food fluids and vitamins.





## TIPOLOGIE E PARAMETRI DI ABBATTIMENTO

Con Polaris puoi inserire i tuoi alimenti una volta usciti direttamente dal forno, garantendoti il **mantenimento assoluto della qualità**.

### Raffreddamento da 90°C a +3°C

🕒 90' max

### Surgelazione da 90°C a -18°C

🕒 240' max

L'abbattimento positivo o negativo può essere fatto in modalità **SOFT** oppure **HARD** in funzione della **tipologia di alimento**, garantendone il rispetto totale.

## Types of blast-chilling parameters

With Polaris you can insert your food once you have left the oven, guaranteeing **absolute quality maintenance**.

### Cooling from 90°C to +3°C

🕒 90' max

### Freezing from 90°C to -18°C

🕒 240' max

The positive or negative blast chilling can be done in **SOFT** or **HARD** mode depending on the **type of food**, ensuring total respect.

## DIFFERENZE DI ABBATTIMENTO SOFT E HARD IN RAFFREDDAMENTO

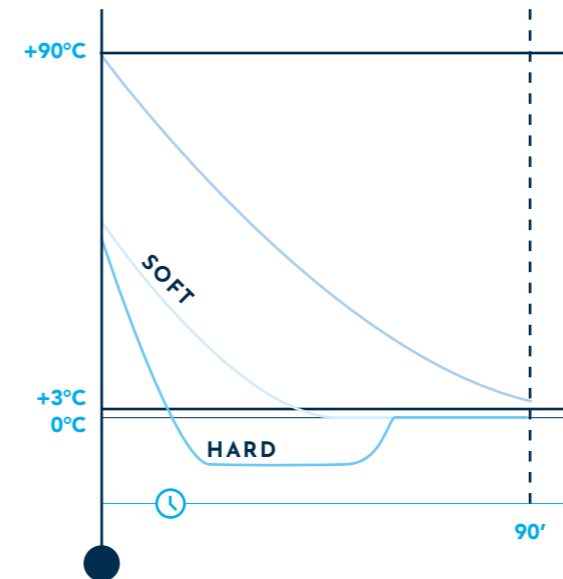

Il rapporto tra la temperatura di esercizio e il tempo necessario al raffreddamento può essere modulato in funzione della diversa struttura dei prodotti. Per un alimento delicato o di piccolo spessore sarà necessario utilizzare un ciclo SOFT, un raffreddamento graduale con diverse scale di T che eviterà il danneggiamento della struttura del prodotto. Nei casi in cui il prodotto avrà uno spessore elevato (per es. delle lasagne), ci sarà bisogno di un processo più intensivo a livello di T di esercizio e dovrà quindi essere utilizzato un ciclo HARD.

### differences in soft and hard chilling in cooling

The relationship between the operating temperature and the time required for cooling can be modulated according to the different structure of the products. For a delicate or thin food, it will be necessary to use a SOFT cycle, a gradual cooling with different T scales that will avoid damage to the product structure. In cases where the product will be very thick (e.g. lasagne), a more intensive process at operating T level will be required and a HARD cycle will have to be used.

## DIFFERENZE DI ABBATTIMENTO SOFT E HARD IN SURGELAZIONE

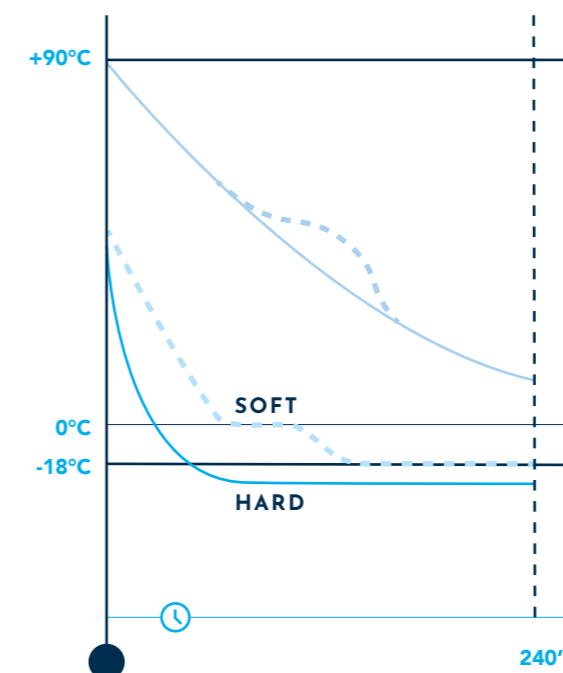

La surgelazione permette una conservazione ottimale particolarmente lunga dei prodotti. Per esempio, se hai la necessità di surgelare dei prodotti appena usciti dal forno, il processo da utilizzare sarà Soft: basterà impostare una serie di T di raffreddamento progressive che permettano un equilibrio nella curva di surgelazione. Una T troppo aggressiva, invece, causerebbe il così detto effetto IGLOO, ossia la chiusura immediata dei pori esterni dell'alimento e il suo non raffreddamento all'interno (in questi casi è necessario utilizzare una prima fase di ciclo SOFT). Prodotti crudi, a temperatura ambiente o con spessori particolarmente significativi possono essere trattati con i cicli HARD.

### differences in soft and hard chilling in freezing

Freezing allows a particularly long optimal storage of the products. For example, should it be necessary to freeze products just out of the oven, use the Soft process: simply set a series of progressive cooling T that allow a balance in the freezing curve. On the other hand, a too aggressive T would cause the so-called IGLOO effect, i.e. the immediate closure of external pores of the food and its non-cooling inside (in these cases use a first phase of SOFT cycle). Raw products, at room temperature or particularly thick, can be treated with HARD cycles.

ABBATTITORI MONOSCOCCA  
LINEA

# JUMPY

monocoque chillers  
Jumpy line

TECNO-  
LOGIA  
FLESSIBI-  
LE, ALLA  
PORTATA  
DI TUTTI

flexible  
technology.  
for everyone

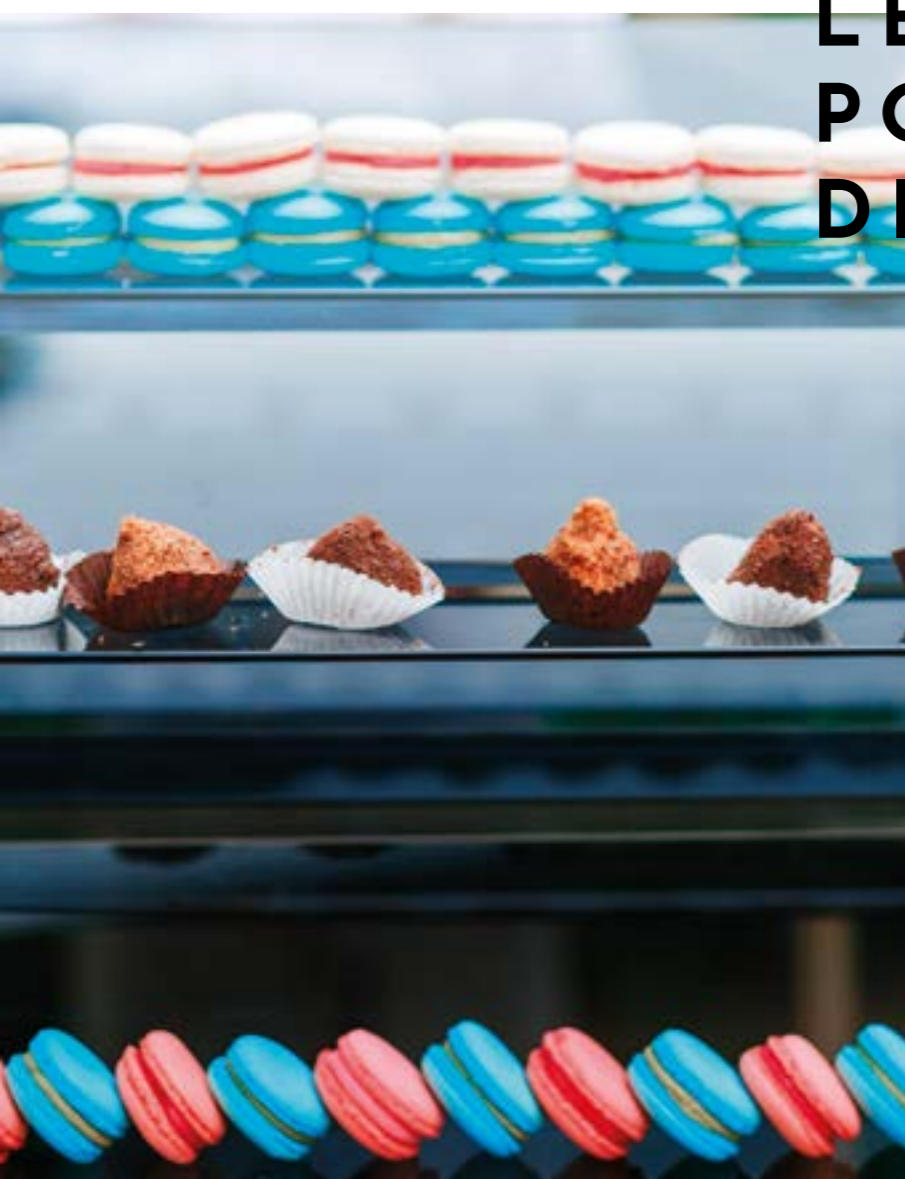

# JUMPY

Compatta e versatile, la linea Jumpy è pensata soprattutto per tutte quelle strutture che hanno **problemi di spazio** ma che non vogliono rinunciare ad un partner del freddo professionale.

*Compact and versatile, the Jumpy line is especially designed for all those structures that have **space problems** but do not want to give up a professional cold partner.*



- > Compatto e versatile
- > Flessibile
- > Soluzioni di spazio

- > *Compact and versatile*
- > *Flexible*
- > *Space solutions*

## PBF030AFG

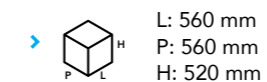

L: 560 mm  
P: 560 mm  
H: 520 mm

### > EN17032

Abb. Pos. / Blast Chilling  
Kg: 8

Abb. Neg. / Blast Freezing  
Kg: 5



x3  
GN2/3

> V/Hz  
220-240/50

## PCF031AFG

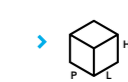

L: 560 mm  
P: 700 mm  
H: 520 mm

### > EN17032

Abb. Pos. / Blast Chilling  
Kg: 8

Abb. Neg. / Blast Freezing  
Kg: 5



x3  
GN 1/1

> V/Hz  
220-240/50

## ABBATTITORI MONOSCOCCA LINEA

# ECO

*monocoque chillers  
Eco line*

Affidabile, solido, di facile utilizzo, la linea ECO è pensata per chi cerca il suo primo alleato in cucina, senza compromessi...

*Reliable, solid, easy to use, the ECO line is designed for those looking for their first ally in the kitchen, without compromise...*



## IL TUO PRIMO ABBAT- TITORE

...  
*your first blast  
chiller...*



### CARATTERISTICHE COSTRUTTIVE ECO:

Costruzione monoscocca in acciaio inox AISI 304 satinato Scotch-Brite sui 4 lati e top

Interno completamente raggiato in acciaio inox AISI 304

Fondo interno stampato a contenimento con pileta centrale per scarico acqua di lavaggio

Isolamento in poliuretano espanso ad alta densità (circa 42 kg/m3) di spessore 60mm, privo di HCFC

Batteria evaporante in rame-alluminio, con trattamento anticorrosivo in cataforesi, con deflettore apribile a bandiera su cerniere, per la pulizia

Batteria condensante in rame con alette in alluminio ad alta resa termica

Resistenza anticondensa, posta sotto la cornice della battuta

Maniglia ergonomica a tutta altezza e guarnizioni magnetiche sui 4 lati della porta

### eco design features:

*Single frame construction with AISI 304 stainless steel, Scotch-Brite brushed on 4 sides and top*

*Interior completely bevelled in AISI 304 stainless steel*

*Internal bottom moulded for containment with central wash water drain*

*60 mm thick high-density polyurethane foam insulation (approx. 42 kg/m3) without HCFC*

*Copper-aluminium evaporating coil, with anti-corrosion treatment in cathoresis, with swing openable deflector on hinges, for cleaning*

*Copper condensing coil with high thermal performance aluminium fins*

*Anti-condensation resistance, placed under the stop frame*

*Ergonomic full-height handle and magnetic seals on 4 sides of the door*



### ALLESTIMENTO INTERNO:

Supporto porta-teglie in acciaio inox AISI 304

coppie guide amovibili ANTIRIBALTA in acciaio inox AISI 304, posizionabili ad incastro ogni 20 mm per GN1/1 o 600x400

Sonda al cuore riscaldata, con 1 punto di misurazione

Microswitch che blocca la ventilazione all'apertura della porta

### internal setup:

Tray holder support in AISI 304 stainless steel

NO-TIPPING removable pairs of guides in AISI 304 stainless steel, can be interlocked every 20 mm for GN1/1 or 600x400

Probe with heated core, with 1 measuring point

Microswitch which blocks ventilation when the door is opened



### GRUPPO REFRIGERANTE:

Protettore termico a salvaguardia del compressore

Sbrinamento manuale

Ventilatori elettronici con flusso indiretto sul prodotto

Fluido refrigerante R452A

Evaporatore con grande superficie di scambio, per un'alta efficienza del sistema di raffreddamento

### cooling unit:

Thermal protector to protect the compressor

Manual defrosting

Electronic fans with indirect flow on product

R452A refrigerant fluid

Evaporator with large exchange surface, for high efficiency of cooling system



### FUNZIONI:

Abbattimento positivo

Abbattimento negativo

### functions:

Blast-chilling

Blast-freezing



### CONTROLLO ELETTRONICO:

Controllo elettronico a membrana

Quadro elettrico organizzato IPX4 frontale, di facile accesso

### electronic control:

Membrane electronic control

Front, easy to access, IPX4 electric panel



### DOTAZIONI A RICHIESTA ACCESSORI:

Kit ruote girevoli, due con freno

Sterilizzatore amovibile

Inversione porta

### supply on demand / accessories:

Rotary wheels kit, two with brake

Removable steriliser

Door inversion



# ECO SIMPLE



## START/STOP AVVIO/ARRESTO DI UN CICLO DI ABBATTIMENTO

Dopo aver collegato l'apparecchiatura elettrica, premendo questo tasto si fa passare la macchina dalla condizione di arresto (Off) allo stato di attesa (Standby) per l'impostazione del ciclo desiderato.

Serve anche per interrompere il funzionamento durante il ciclo di abbattimento/congelamento/conservazione.

### *start/stop of a blast chilling cycle*

*After having connected the machine to the power supply, press this button to change the machine from the shutdown (Off) to the Stand-by condition, in order to set the desired cycle.*

*The button is also used to interrupt operation during the blast chill/shock freeze/conservation cycle.*



## UP

Incremento valori, visualizza la temperatura della sonda spillone.

*Increase values, displays the temperature of the food probe.*



## DOWN

Decremento valori, visualizza il tempo trascorso del ciclo.

*Decrease values, displays cycle time elapsed.*



## RISCALDAMENTO SONDA

Riscaldamento per estrazione sonda spillone.

### *probe heating*

*Heating for extraction of food probe.*



## DEFROST AVVIO/ARRESTO SBRINAMENTO

Premendo per 3 secondi il tasto si attiva la modalità sbrinamento con porta aperta.

### *start/stop defrost*

*By pressing the button for 3 seconds activates the defrost mode with door open.*



## SOFT

Selezione ciclo soft di abbattimento (+3°C) o di congelamento (-18°C).

*Selection of soft blast chill cycle (+3°C) or shock freeze (-18°C).*



## +3°C ABBATTIMENTO

Selezione abbattimento +3°C.

### *+3°C blast chill*

*Selection of blast chill at +3°C.*



## -18°C CONGELAMENTO

Selezione congelamento -18°C.

### *-18°C freezing*

*Selection of shock freeze at -18°C.*



## ABBATTITORI MONOSCOCCA LINEA

# ECO

monocoque chillers  
Eco line



### RAFFREDDAMENTO SOFT +3°C *soft cooling cycle +3°C*

Ciclo di raffreddamento delicato per portare l'alimento ad una temperatura di 3°C al cuore con un ciclo di lavoro tra gli 0°C ed i +2°C in camera, conservazione a +2°C.

Ciclo particolarmente indicato per alimenti delicati di piccolo spessore quali ad esempio: pasta, riso, verdure, pasticceria, pesce.

*Delicate cooling cycle to lower the core temperature of the food to 3°C with a work cycle between 0°C and +2°C in the chamber, preservation at +2°C.*

*Cycle particularly suitable for thin, delicate food, such as pasta, rice, vegetables, pastries, fish.*



### SURGELAZIONE SOFT -18°C *soft freezing cycle -18°C*

Ciclo di surgelamento delicato per portare l'alimento ad una temperatura di -18°C al cuore, che prevede le seguenti fasi:

1° — Fase fino al raggiungimento di 20°C al cuore con T° in cella a 0°C;

2° — Fase fino al raggiungimento di -18°C al cuore con T° in cella di -40°C, conservazione a -20°C;

Ciclo di lavoro particolarmente adatto per tutti i prodotti caldi che si intendono surgelare immediatamente.

*Delicate freezing cycle to lower the core temperature of the food to -18°C with the following phases:*

*1° — Phase to reach 20°C at the core with T° in the cell of 0°C;*

*2° — Phase to reach -18°C at the core with T° in the cell of -40°C, preservation at -20°C;*

*Work cycle particularly suitable for hot products which need to be frozen immediately.*

# CICLI DI LAVORO

work cycles



### RAFFREDDAMENTO HARD +3°C *hard cooling cycle +3°C*

Ciclo di raffreddamento particolarmente incisivo per portare l'alimento ad una temperatura al cuore di 3°C seguendo le seguenti fasi:

1° — Fase fino al raggiungimento di 15°C al cuore con T° in cella di -25°C;

2° — Fase fino al raggiungimento di 3°C al cuore con ciclo di lavoro tra gli 0°C ed i +2°C in camera, conservazione a +2°;

Ciclo di lavoro particolarmente indicato per raffreddare alimenti cotti in sottovuoto, carni, sughi, brodi.

*Cooling cycle particularly effective for lowering the core temperature of food to 3°C with the following phases:*

*1° — Phase to reach 15°C at the core with T° in the cell of -25°C;*

*2° — Phase to reach 3°C at the core with work cycle between 0°C and +2°C in the cell, preservation at +2°;*

*Work cycle particularly suitable for cooling vacuum cooked food, meat, sauces, broth.*



### SURGELAZIONE HARD -18°C *hard freezing cycle -18°C*

Ciclo di surgelazione particolarmente incisivo per portare l'alimento ad una temperatura di -18°C al cuore, con un ciclo di lavoro che può raggiungere i -40°C.

Ciclo di lavoro particolarmente adatto per la surgelazione di prodotti crudi o freddi.

*Freezing cycle particularly effective for lowering the core temperature of food to -18°C with a work cycle which can reach -40°C.*

*Work cycle particularly suitable for freezing raw or cold products.*



# ABBATTITORI MONOSCOCCA LINEA

# ECO

monocoque chillers  
Eco line



## 050 ECO DF

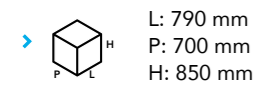

- > **EN17032**  
Abb. Pos. / Blast Chilling  
Kg: 15
- Abb. Neg. / Blast Freezing  
Kg: 10

- > **kW/Kg**  
Abb. Pos. / Blast Chilling  
Kg: 0,09
- Abb. Neg. / Blast Freezing  
Kg: 0,37

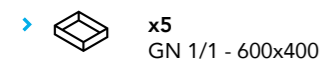

- > **V/Hz**  
220-240/50

## 050 ECO COMPACT STAFF

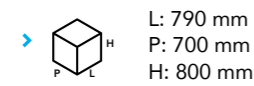

- > **EN17032**  
Abb. Pos. / Blast Chilling  
Kg: 20
- Abb. Neg. / Blast Freezing  
Kg: 12

- > **kW/Kg**  
Abb. Pos. / Blast Chilling  
Kg: 0,13
- Abb. Neg. / Blast Freezing  
Kg: 0,33



- > **V/Hz**  
220-240/50

## 050 ECO COMPACT

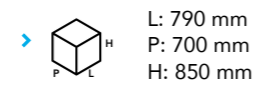

- > **EN17032**  
Abb. Pos. / Blast Chilling  
Kg: 20
- Abb. Neg. / Blast Freezing  
Kg: 12

- > **kW/Kg**  
Abb. Pos. / Blast Chilling  
Kg: 0,13
- Abb. Neg. / Blast Freezing  
Kg: 0,33



- > **V/Hz**  
220-240/50

## 051 ECO

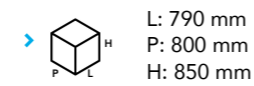

- > **EN17032**  
Abb. Pos. / Blast Chilling  
Kg: 20
- Abb. Neg. / Blast Freezing  
Kg: 12

- > **kW/Kg**  
Abb. Pos. / Blast Chilling  
Kg: 0,13
- Abb. Neg. / Blast Freezing  
Kg: 0,33

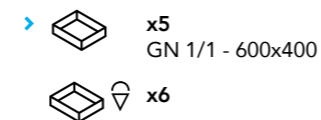

- > **V/Hz**  
220-240/50

## 081 ECO

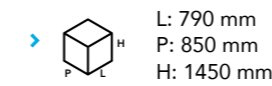

- > **EN17032**  
Abb. Pos. / Blast Chilling  
Kg: 32
- Abb. Neg. / Blast Freezing  
Kg: 24

- > **kW/Kg**  
Abb. Pos. / Blast Chilling  
Kg: 0,09
- Abb. Neg. / Blast Freezing  
Kg: 0,25

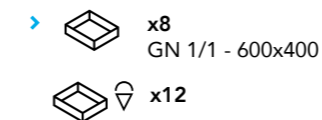

- > **V/Hz**  
220-240/50

## 121 ECO

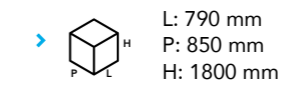

- > **EN17032**  
Abb. Pos. / Blast Chilling  
Kg: 44
- Abb. Neg. / Blast Freezing  
Kg: 32

- > **kW/Kg**  
Abb. Pos. / Blast Chilling  
Kg: 0,06
- Abb. Neg. / Blast Freezing  
Kg: 0,29

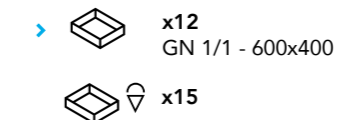

- > **V/Hz**  
380-420/3/50+N

## 161 ECO

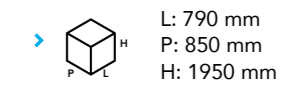

- > **EN17032**  
Abb. Pos. / Blast Chilling  
Kg: 70
- Abb. Neg. / Blast Freezing  
Kg: 54

- > **kW/Kg**  
Abb. Pos. / Blast Chilling  
Kg: 0,09
- Abb. Neg. / Blast Freezing  
Kg: 0,27

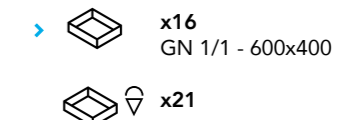

- > **V/Hz**  
380-420/3/50+N





## ABBATTITORI MONOSCOCCA LINEA

# KEEP

Nuovi Abbattitori KEEP, la tua scelta ogni giorno. Concepiti per una resa professionale di altissima qualità mantenendo bassi i consumi, l'abbattitore di POLARIS Linea KEEP offre oggi un bilanciamento dei componenti in grado di garantire una resa estrema del tuo processo di raffreddamento e surgelazione. Grazie all'innovativa tecnologia ad inversione di ciclo, KEEP raggiunge i 65°C in camera, permettendoti uno scongelamento controllato con un impatto energetico ridotto. Compressore Scroll Technology per una silenziosità ed una performance di altissima qualità e costante nel tempo. Connettività IOT 4.0 di POLARIS, per interagire con il tuo KEEP anche da remoto, permettendoti se necessario di cambiare i tuoi parametri, effettuare diagnostiche e verificare lo stato del tuo processo comodamente dal tuo ufficio.

### *monocoque chillers Keep line*

New KEEP Blast Chillers, your choice every day. Designed for top quality professional performance with low consumption, the POLARIS KEEP Line Blast Chiller now offers improved balancing between the components to ensure a high yield of your cooling and freezing process. Thanks to the innovative cycle inversion technology, KEEP reaches 65°C in the chamber, ensuring controlled thawing with a reduced energy impact. Scroll Technology compressor for quiet operation while ensuring high and constant quality performance over time. POLARIS IOT 4.0 connectivity, to also interact with your KEEP remotely, allowing you – if necessary – to change your parameters, perform diagnostics and check the status of your process from the comfort of your office.

NEW  
PRODUCT  
2020

# KEEP it fresh

 BLAST-CHILLING,  
 BLAST-FREEZING,  
 THAWING



CONNETTIVITÀ  
BIDIREZIONALE  
*Bi-directional  
connectivity*

FUNZIONI:  
ABBATTIMENTO  
POSITIVO,  
ABBATTIMENTO  
NEGATIVO,  
SCONGELAMENTO  
*Functions:  
Blast-chilling,  
Blast-freezing,  
Thawing*

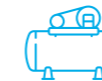
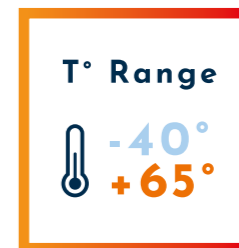

COMPRESSORE  
SCROLL  
*Scroll  
technology  
compressor*

SBRINAMENTO  
A GAS CALDO  
*Hot gas  
defrosting*



DISPLAY  
FULL-TOUCH 7"



FUNZIONE DI  
SCONGELAMENTO  
A RIDOTTO  
IMPATTO  
ENERGETICO CON  
INVERSIONE DI  
CICLO  
*Function with  
reduced energy  
impact and cycle  
inversion*

PREDISPOSTI  
PER IMPIANTI  
A CO<sub>2</sub>  
*Set up for  
CO<sub>2</sub> systems*

FLESSIBILITÀ OPERATIVA CON SET UP  
INTERNO GASTRONORM&EURONORM  
CONTEMPORANEO  
*Operational flexibility with  
contemporary Gastronorm&Euronorm  
internal setup*





ABBATTITORI MONOSCOCCA  
LINEA

# KEEP

monocoque chillers  
Keep line



## K051

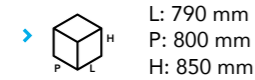

L: 790 mm  
P: 800 mm  
H: 850 mm

### > EN17032

Abb. Pos. / Blast Chilling  
Kg: 23

Abb. Neg. / Blast Freezing  
Kg: 15

### > kW/Kg

Abb. Pos. / Blast Chilling  
Kg: 0,08

Abb. Neg. / Blast Freezing  
Kg: 0,11

> x5  
GN 1/1 - 600x400

> x6  
(165x360x120)

> V/Hz  
230/1/50

## K081



L: 790 mm  
P: 850 mm  
H: 1450 mm

### > EN17032

Abb. Pos. / Blast Chilling  
Kg: 34

Abb. Neg. / Blast Freezing  
Kg: 25

### > kW/Kg

Abb. Pos. / Blast Chilling  
Kg: 0,11

Abb. Neg. / Blast Freezing  
Kg: 0,14

> x8  
GN 1/1 - 600x400

> x12  
(165x360x120)

> V/Hz  
230/1/50

## K121



L: 790 mm  
P: 850 mm  
H: 1800 mm

### > EN17032

Abb. Pos. / Blast Chilling  
Kg: 47

Abb. Neg. / Blast Freezing  
Kg: 35

### > kW/Kg

Abb. Pos. / Blast Chilling  
Kg: 0,09

Abb. Neg. / Blast Freezing  
Kg: 0,14

> x12  
GN 1/1 - 600x400

> x15  
(165x360x120)

> V/Hz  
400/3/50

## K161



L: 790 mm  
P: 850 mm  
H: 1950 mm

### > EN17032

Abb. Pos. / Blast Chilling  
Kg: 73

Abb. Neg. / Blast Freezing  
Kg: 60

### > kW/Kg

Abb. Pos. / Blast Chilling  
Kg: 0,06

Abb. Neg. / Blast Freezing  
Kg: 0,10

> x16  
GN 1/1 - 600x400

> x21  
(165x360x120)

> V/Hz  
400/3/50



## ABBATTITORI MONOSCOCCA LINEA



Impara a conoscerlo... non potrai più farne a meno. Sarà il tuo assistente personale 24h su 24h.

*monocoque chillers  
Genius line*

*Learn to know it... you will not be able to do without it. It will be your personal assistant 24h hours a day.*



# GENIA- LE PRO- PRIO IN TUTTO

*Ingenious  
all the way  
around*



### RAFFREDDAMENTO

Genius **raffredda velocemente** i tuoi prodotti, direttamente dal forno fino alla soglia di sicurezza di 3°C, nel totale rispetto della struttura e delle proprietà del prodotto.

### *cooling*

*Genius quickly cools your products, directly from the oven, up to the safe threshold of 3°C, in total respect of the structure and product properties.*



### SURGELAZIONE

Genius surgela velocemente a -18°C il cuore del prodotto, garantendoti la possibilità di una **lunga conservazione**, mantenendo inalterate le **proprietà**

### *freezing*

*Genius quickly freezes the product core at -18°C, ensuring you the option of long conservation, keeping the properties unchanged organoleptic and structural*

**organolettiche e strutturali** dello stesso e creando una rete di delicati micro-cristalli veloci da dissipare in fase di scongelamento.

*of the same and creating a network of delicate micro-crystals that can be quickly dissipated during defrosting.*



### SCONGELAMENTO

Scongela i tuoi prodotti in **totale sicurezza**. Indica lo spessore e per quando lo desideri pronto, il resto lo fa Genius, il tuo **assistente del freddo**.

### *thawing*

*Defrost your products in total safety. Indicate the thickness and for when you want it ready, the rest is done by Genius, your cold assistant.*



### LIEVITAZIONE

Ideale per i processi notturni o posticipati, Genius ti permette di **programmare il tuo ciclo di lievitazione** indicando il giorno e l'ora desiderati per terminare il lavoro. Genius si attiverà con una prima fase di mantenimento della T di conservazione per poi passare a sviluppare tutta la curva di lievitazione, fino a coincidere con i tempi da te indicati. La connessione acqua permette inoltre un processo di lievitazione bilanciato e costante, garantendo **uniformità dei risultati nel tempo**.

### *proofing*

*Ideal for nocturnal or postponed processes, Genius allows you to program your proofing cycle, indicating the desired day and time to finish the job. Genius will activate with a first maintenance phase of the storage T to then develop the entire rising curve, until it coincides with the times indicated by you. The water connection also allows a balanced and constant proofing process, ensuring uniform results every time.*



## COTTURA A BASSA TEMPERATURA

Libera il tuo forno ed affida la cottura a bassa temperatura a Genius.

Ideale per i **processi notturni**, cuoce a bassa temperatura i tuoi prodotti nel totale rispetto delle loro proprietà. Una volta terminato, passerà alla fase di **raffreddamento o surgelazione**, liberandoti dall'**obbligo di presenza** e mantenendo il prodotto all'apice della sua qualità. **Tu programmi, Genius lavora per te.**



## PASTORIZZAZIONE

Genius ti permette di lavorare in modo **professionale** a tutti i livelli di conservazione, dandoti la possibilità di **pastorizzare e raffreddare** i prodotti, nel totale rispetto delle norme di sicurezza\*.

\*Il primo prodotto processato dovrà in ogni caso essere sempre sottoposto ad apposito controllo preliminare presso l'ufficio sanitario competente per la definizione precisa dei tempi di shelf life e la standardizzazione del tuo processo.

## low temperature cooking

*Free your oven and entrust the low cooking to Genius.*

*Ideal for **nocturnal processes**, cooks your products at low temperature, in total respect of their properties. Once finished, it will go to the **cooling or freezing** phase, releasing you from the **obligation to be present** and keeping the product at the apex of its quality. **You program, Genius works for you.***

## pasteurisation

*Genius allows you to work **professionally** at all conservation levels, giving you the opportunity of **pasteurising and cooling** the products, in full compliance with the safety regulations\*.*

*\*The first processed product must, in any case, always be subjected to specific preliminary check at the competent health department for the precise definition of shelf times and the standardisation of your process.*



## DISIDRATAZIONE

Genius dà un  **tocco di fantasia** alle tue creazioni con prodotti freschi disidratati secondo i tuoi bisogni.

## dehydration

*Genius gives a **touch of fantasy** to your creations with fresh products dehydrated according to your needs.*

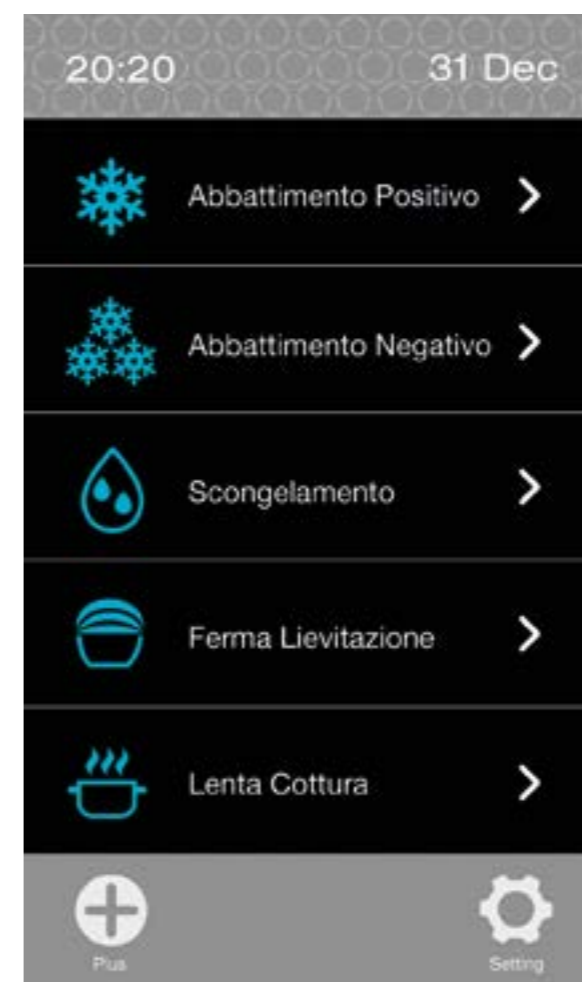

— *blast-chilling*

— *blast-freezing*

— *thawing*

— *proofing*

— *low temperature cooking*









## ABBATTITORI MONOSCOCCA LINEA

# GENIUS

monocoque chillers  
Genius line



**1** DISPLAY FACILE  
E INTUITIVO  
*easy and intuitive  
display*

**2** COMPLETAMENTE  
PERSONALIZZABILE,  
GENIUS LAVORA PER TE.  
*fully  
customisable,  
Genius works for you*

**3** CREA LA TUA  
LISTA DEI PREFERITI  
*create your  
list of favourites*



**4** REGISTRA  
IL TUO CICLO  
*record  
your cycle*



**5** CICLO  
CONTINUO  
*continuous  
cycle*



**6** SURGELA  
IN SICUREZZA  
*freeze  
safely*



L'innovativo processo **Anisakis Killer** di Genius è stato pensato appositamente per i prodotti ittici freschi. Un trattamento obbligatorio per garantirti l'**assenza del parassita Anisakis** e conservare i tuoi prodotti in **sicurezza** a seconda dei bisogni. Non rinunciare ad acquistare i tuoi prodotti ittici nella giusta stagione e non rimanerne senza, soprattutto fuori periodo.

*The innovative Genius **Anisakis Killer** process was designed specifically for fresh fish products. A mandatory treatment to ensure the absence of Anisakis parasite and keep your products **safe** according to needs. Do not give up purchasing fish products in the right season and do not stay without them, especially out of season.*

# ABBATTITORI MONOSCOCCA LINEA



monocoque chillers  
Genius line



## GM061

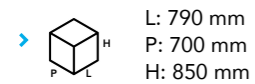

L: 790 mm  
P: 700 mm  
H: 850 mm

### > EN17032

Abb. Pos. / Blast Chilling  
Kg: 20

Abb. Neg. / Blast Freezing  
Kg: 13

### > kW/Kg

Abb. Pos. / Blast Chilling  
Kg: 0,07

Abb. Neg. / Blast Freezing  
Kg: 0,25



x6  
GN 1/1

x6  
600x400

> V/Hz  
230/1/50

## GM121



L: 790 mm  
P: 820 mm  
H: 1320 mm

### > EN17032

Abb. Pos. / Blast Chilling  
Kg: 28

Abb. Neg. / Blast Freezing  
Kg: 18

### > kW/Kg

Abb. Pos. / Blast Chilling  
Kg: 0,07

Abb. Neg. / Blast Freezing  
Kg: 0,22



x12  
GN 1/1

x12  
600x400

> V/Hz  
230/1/50

## GM171



L: 790 mm  
P: 820 mm  
H: 1800 mm

### > EN17032

Abb. Pos. / Blast Chilling  
Kg: 40

Abb. Neg. / Blast Freezing  
Kg: 26

### > kW/Kg

Abb. Pos. / Blast Chilling  
Kg: 0,06

Abb. Neg. / Blast Freezing  
Kg: 0,19

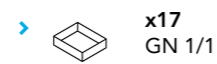

x17  
GN 1/1

x17  
600x400

> V/Hz  
400/3/50

## GM231



L: 790 mm  
P: 820 mm  
H: 1950 mm

### > EN17032

Abb. Pos. / Blast Chilling  
Kg: 61

Abb. Neg. / Blast Freezing  
Kg: 40

### > kW/Kg

Abb. Pos. / Blast Chilling  
Kg: 0,07

Abb. Neg. / Blast Freezing  
Kg: 0,21

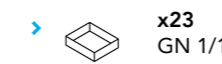

x23  
GN 1/1

x23  
600x400

> V/Hz  
400/3/50

## GM172



L: 1100 mm  
P: 1050 mm  
H: 1800 mm

### > EN17032

Abb. Pos. / Blast Chilling  
Kg: 79

Abb. Neg. / Blast Freezing  
Kg: 53

### > kW/Kg

Abb. Pos. / Blast Chilling  
Kg: 0,08

Abb. Neg. / Blast Freezing  
Kg: 0,27

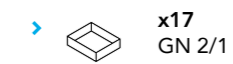

x17  
GN 2/1

x17  
600x800

> V/Hz  
400/3/50

# ABBATTITORI MONOSCOCCA

monocoque chillers



MODELLO <i>model</i>	GRIGLIE <i>grids</i>		SPAZIO TEGLIA mm <i>tray space mm</i>	DIMENSIONI ESTERNE LXPXA mm <i>external dimensions lxdxh mm</i>	RESA MAX EN17032 ABBATTIMENTO POSITIVO (KG) <i>chilling - EN17032 (Kg)</i>	RESA MAX EN17032 ABBATTIMENTO NEGATIVO (KG) <i>freezing - EN17032 (Kg)</i>	CONSUMO ENERGETICO EN17032 (+10°C) (kW/Kg) <i>energy consumption EN17032 (+10°C) (kW/Kg)</i>	CONSUMO ENERGETICO EN17032 (-18°C) (kW/Kg) <i>energy consumption EN17032 (-18°C) (kW/Kg)</i>	POTENZA REFRIGERANTE W -30°C + 45°C EN12900 <i>cooling power W -30°C + 45°C EN12900</i>	
	GN1/1 600X400	GN2/1 GN2/3 600X800								
<b>JUMPY</b>										
PBF030AFG		3	80	560x560/595x520	10	-	0,12	-	-	
PBF031AFG	3		80	560x700/735x520	10	-	0,12	-	-	
<b>ECO</b>										
050 ECO DF		5		790x700x850	15	10	0,09	0,37	-	
050 ECO COMPACT STAFF	5			790x700x800	20	12	0,13	0,33	-	
050 ECO COMPACT	5			790x700x850	20	12	0,13	0,33	-	
051 ECO		5		790x800x850	20	12	0,13	0,33	-	
081 ECO		8		790x850x850	32	24	0,09	0,25	-	
121 ECO		12		790x850x1800	44	32	0,06	0,29	-	
161 ECO		16		790x850x1950	70	54	0,09	0,27	-	
<b>KEEP</b>										
KEEP 051		5	45	790X800X850	23	15	0,08	0,11	3177	
KEEP 081		8	45	790X850X1450	34	25	0,11	0,14	6180	
KEEP 121		12	45	790X850X1800	47	35	0,09	0,14	9156	
KEEP 161		16	45	790X850X1950	73	60	0,06	0,10	9156	
<b>GENIUS</b>										
GM061	6	6	45	790X720X850	20	13	0,07	0,25	-	
GM121	12	12	45	790X820X1320	28	18	0,07	0,22	-	
GM171	17	17	45	790X820X1800	40	26	0,06	0,19	-	
GM231	23	23	45	790X820X1950	61	40	0,07	0,21	-	
GM172			17	17	45	1100X1050X1800	79	53	0,08	0,27



## ABBATTITORI A CARRELLO LINEA

# GENIUS

trolley chillers  
Genius line



## GENIA- LE PRO- PRIO IN TUTTO

ingenious  
all the way  
around

Polaris ha il piacere di presentare la nuova gamma di abbattitori a carrello Genius, ampia e versatile, ideata per rispondere ai **più elevati standard qualitativi** richiesti dal mercato.

Innovazioni tecniche, affidabilità, robustezza e soluzioni moderne di design, fanno della gamma abbattitori a carrello Genius il partner ideale per tutte le **grandi strutture di processo** presenti sul mercato, quali ad esempio: ristorazione collettiva, hotel, strutture ospedaliere, supermercati e simili.

Con Genius sarà possibile affrontare **professionalmente** l'ottimizzazione e l'organizzazione dei tuoi flussi produttivi.

*Polaris is pleased to present the new range of Genius trolley chillers, wide and versatile, designed to meet the **highest quality standards** required by the market.*

*Technical innovations, reliability, sturdiness and modern design solutions to make the Genius trolley chillers the ideal partner for all **large process structures** on the market, such as, for example: catering, hotels, hospitals, supermarkets and the like.*

*With Genius it will be possible to **professionally** deal with the optimisation and organisation of your production flows.*



### INTERFACCIA TOUCH

Gli abbattitori a carrello Genius presentano un'interfaccia touchscreen da 7" estremamente **intuitiva e pratica**, pensata per rispondere velocemente a tutte le esigenze degli operatori. Con Genius, hai la possibilità di personalizzare il tuo percorso di lavoro, impostando i parametri di ogni ciclo operativo **a seconda delle tue esigenze**. Genius lavora per te e con te.

### touch interface

*The Genius trolley chillers have an extremely **intuitive and practical** 7" touchscreen interface, designed to quickly meet all operators' needs. With Genius, you have the option to customise your work path, setting the parameters of each operating cycle **depending on your needs**. Genius works for you and with you.*



### FUNZIONI

Raffreddamento (+3°C), Surgelazione (-18°C), Scongellamento, Lievitazione, Cottura a bassa temperatura, Pastorizzazione, Disidratazione controllata.

### functions

*Cooling (+3°C), Deep freezing (-18°C), Defrosting, Rising, Low-temperature cooking, Pasteurisation, Controlled dehydration.*



### FLESSIBILITÀ

Cicli preimpostati per tipologia di prodotto, permette a Genius di suggerirti sempre il **percorso migliore** per il trattamento del tuo flusso di lavoro, garantendoti la possibilità di operare in tutta serenità e semplicità.

### flexibility

*Cycles preset by product type, allows Genius to always suggest the **best path** to treat your workflow, ensuring the possibility to operate peacefully and simply.*





### CONNETTIVITÀ

Sempre connessi per un monitoraggio totale del tuo processo di lavoro. Scarico dati via WiFi o USB Key.

#### connectivity

*Always connected for complete monitoring of your work process. Data download via WiFi or USB Key.*



### SONDA MULTILEVEL

Sonda con 4 punti di lettura per darti un dato assolutamente affidabile.

#### multilevel probe

*Probe with 4 reading points to provide an absolutely reliable data.*



### SBRINAMENTO

Manuale a porte aperte, decidi tu quando intervenire senza rischi di danneggiare il tuo prodotto.

#### defrosting

*Manual with open doors, you decide when to intervene without the risk of damaging your product.*



### CO2

Allacciabile ad impianti a CO2 (solo sulle versioni STD).

#### CO2

*Can be connected to CO2 systems (only on STD versions).*



### TECNOLOGIA INVERTER SYSTEM TERMOSTATICA ELETTRONICA (OPZIONALE)

Qualità e controllo totale del processo di raffreddamento con la nuova termostatica elettronica e sistema inverter, per garantirti un **risultato eccellente**, sempre.

#### electronic Thermostat Inverter System technology (optional)

*Quality and total control of the cooling process with the new electronic thermostat and inverter system, to ensure an **excellent result**, always.*



### COMPRESSORE BITZER

Marchio sinonimo di garanzia totale nel mondo dei compressori. Assicura la correttezza delle temperature, garantendo ai sistemi un funzionamento privo di errori ed **estremamente efficiente** dal punto di vista energetico.

#### Bitzer Compressor

*Brand synonymous of total guarantee in the world of compressors. Ensures correct temperatures, guaranteeing systems an error-free and **extremely energy-efficient** operation.*



### VERSIONE STARDARD

Raffreddamento e Surgelazione (+3°C,-18°C), possibilità di predisposizione per impianti a CO2.

#### standard version

*Cooling and Deep Freezing (+3°C,-18°C), available with set-up for CO2 systems.*



### VERSIONE PLUS

Multifunzione (+85°C, -40°C)

**Funzioni: Raffreddamento (+3°C), Surgelazione (-18°C), Scongelamento, Lievitazione, Cottura a bassa temperatura, Pastorizzazione, Disidratazione controllata.**

#### plus version

*Multifunction (+85°C, -40°C)*

**Functions: Cooling (+3°C), Deep freezing (-18°C), Defrosting, Rising\*, Low-temperature cooking, Pasteurisation, Controlled dehydration.**





**DETTAGLI TECNICI**  
technical details





## ABBATTITORI A CARRELLO LINEA



trolley chillers  
Genius line

Genius ti permette di scegliere tra due linee di prodotto: **Standard**, pensata esclusivamente per il raffreddamento e la surgelazione professionale, e **Plus**, che racchiude tutti i programmi multifunzione presenti nella linea Genius.

Genius allows you to choose between two product lines: **Standard** designed exclusively for professional cooling and freezing, and **Plus** that encloses all multifunction programmes present in the Genius line.

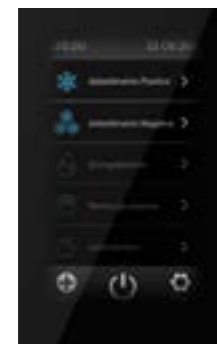

# SERIE R

series R



### GCR201

> Carrelli / Trolleys:  
1x GN 1/1 (600x400)

>  L: 1500 mm  
P: 1330 mm  
H: 2230 mm

> **EN17032**  
Abb. Pos. / Blast Chilling  
Kg: 170  
Abb. Neg. / Blast Freezing  
Kg: 120

>  x20  
GN 1/1

> V/Hz  
380-420/3/50 + N

### GCR202

> Carrelli / Trolleys:  
1x GN 2/1 (600x800)

>  L: 1700 mm  
P: 1530 mm  
H: 2230 mm

> **EN17032**  
Abb. Pos. / Blast Chilling  
Kg: 220  
Abb. Neg. / Blast Freezing  
Kg: 150

>  x20  
GN 2/1

> V/Hz  
380-420/3/50 + N

# ABBATTITORI A CARRELLO LINEA



trolley chillers  
Genius line

# SERIE GN1

series GN1



## GC100 IP

- > Carrelli / Trolleys:  
1x GN 1/1 (600x400)  
1x GN 2/1 (600x800)

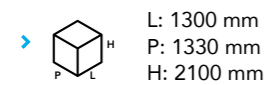

- > EN17032  
Abb. Pos. / Blast Chilling  
Kg: 160  
  
Abb. Neg. / Blast Freezing  
Kg: 110

- > 20x GN 1/1  
 20x GN 2/1

- > V/Hz  
380-420/3/50 + N

## GC151 IP

- > Carrelli / Trolleys:  
1x GN 1/1 (600x400)

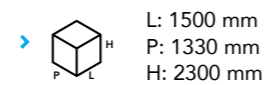

- > EN17032  
Abb. Pos. / Blast Chilling  
Kg: 280  
  
Abb. Neg. / Blast Freezing  
Kg: 200

- > 20x GN 1/1

- > V/Hz  
380-420/3/50 + N

## GC151

- > Carrelli / Trolleys:  
1x GN 1/1 (600x400)

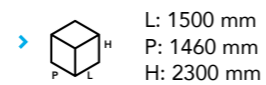

- > EN17032  
Abb. Pos. / Blast Chilling  
Kg: 280  
  
Abb. Neg. / Blast Freezing  
Kg: 200

- > 20x GN 1/1

- > V/Hz  
380-420/3/50 + N

## GC301

- > Carrelli / Trolleys:  
2x GN 1/1 (600x400)

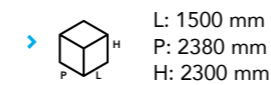

- > EN17032  
Abb. Pos. / Blast Chilling  
Kg: 560  
  
Abb. Neg. / Blast Freezing  
Kg: 400

- > 40x GN 1/1

- > V/Hz  
380-420/3/50 + N

## GC401

- > Carrelli / Trolleys:  
3x GN 1/1 (600x400)

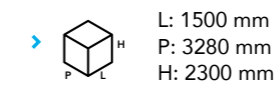

- > EN17032  
Abb. Pos. / Blast Chilling  
Kg: 840  
  
Abb. Neg. / Blast Freezing  
Kg: 600

- > 60x GN 1/1

- > V/Hz  
380-420/3/50 + N

## GC501

- > Carrelli / Trolleys:  
4x GN 1/1 (600x400)

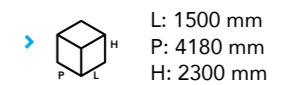

- > EN17032  
Abb. Pos. / Blast Chilling  
Kg: 1120  
  
Abb. Neg. / Blast Freezing  
Kg: 800

- > 80x GN 1/1

- > V/Hz  
380-420/3/50 + N

# ABBATTITORI A CARRELLO LINEA



trolley chillers  
Genius line

# SERIE GN2

series GN2



## GC202 IP

- > Carrelli / Trolleys:  
2x GN 1/1 (600x400)  
1x GN 2/1 (600x800)

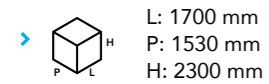

- > EN17032  
Abb. Pos. / Blast Chilling  
Kg: 350  
Abb. Neg. / Blast Freezing  
Kg: 240

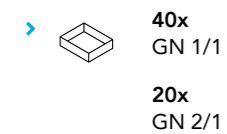

- > V/Hz  
380-420/3/50 + N

## GC202

- > Carrelli / Trolleys:  
2x GN 1/1 (600x400)  
1x GN 2/1 (600x800)

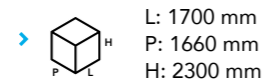

- > EN17032  
Abb. Pos. / Blast Chilling  
Kg: 350  
Abb. Neg. / Blast Freezing  
Kg: 240

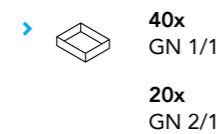

- > V/Hz  
380-420/3/50 + N

## GC402

- > Carrelli / Trolleys:  
4x GN 1/1 (600x400)  
2x GN 2/1 (600x800)

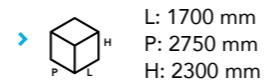

- > EN17032  
Abb. Pos. / Blast Chilling  
Kg: 700  
Abb. Neg. / Blast Freezing  
Kg: 480

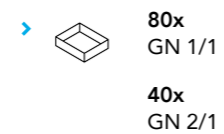

- > V/Hz  
380-420/3/50 + N

## GC602

- > Carrelli / Trolleys:  
6x GN 1/1 (600x400)  
3x GN 2/1 (600x800)

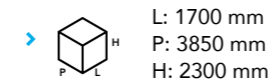

- > EN17032  
Abb. Pos. / Blast Chilling  
Kg: 1050  
Abb. Neg. / Blast Freezing  
Kg: 720

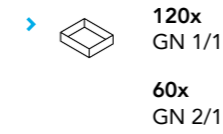

- > V/Hz  
380-420/3/50 + N

## GC802

- > Carrelli / Trolleys:  
8x GN 1/1 (600x400)  
4x GN 2/1 (600x800)

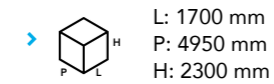

- > EN17032  
Abb. Pos. / Blast Chilling  
Kg: 1400  
Abb. Neg. / Blast Freezing  
Kg: 960

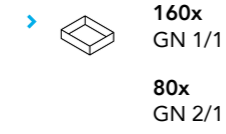

- > V/Hz  
380-420/3/50 + N



# ABBATTITORI A CARRELLO

trolley chillers

**GAS**  
gas R452A

**TENSIONE**  
voltage 380-420/3/50 + N



NOME name	VERSIONE version	ABB POSITIVO (KG) Blast Chilling (kg)	ABB NEGATIVO (KG) Blast Freezing (kg)	RANGE MASSIMO T°C IN CAMERA maximum t°C range in chamber	N° PORTE no. of doors	EN 1, GN 1/1, 600X400	EN 2, GN 2/1, 600X800		DIMENSIONI INTERNE LXPXA mm internal dimensions lxdxh mm	DIMENSIONI ESTERNE LXPXA mm external dimensions lxdxh mm	PESO NETTO KG net weight kg	MAX POT. ELETTR. W max electr. pow. W	
												MAX CONS. ELETTR. A max electr. cons. A	
GC100 1P	STD	160	110	+85°/-40°	1	1	1		740X940X1700	1300X1330X2100	345	755	2,8
	PLUS											-	-
GC151 1P	STD	280	200	+85°/-40°	1	1	-		700X880X2020	1500X1330X2300	490	2775	5,5
	PLUS											7575	12,4
GC151	STD	280	200	+85°/-40°	2	1	-		700X880X2020	1500X1460X2300	490	2865	5,9
	PLUS											7665	12,8
GC301	STD	560	400	+85°/-40°	2	2	-		700X1780X2020	1500X2380X2300	980	5400	10,3
	PLUS											15000	24,2
GC401	STD	840	600	+85°/-40°	2	3	-		700X2680X2020	1500X3280X2300	1470	7935	14,7
	PLUS											22335	35,6
GC501	STD	1120	800	+85°/-40°	2	4	-		700X3580X2020	1500X4180X2300	1960	10470	19,2
	PLUS											29670	47,0
GC202 1P	STD	350	240	+85°/-40°	1	2	1		900X1080X2020	1700X1530X2300	650	2775	5,5
	PLUS											7575	12,4
GC202	STD	350	240	+85°/-40°	2	2	1		900X1080X2020	1700X1660X2300	650	2865	5,9
	PLUS											7665	12,8
GC402	STD	700	480	+85°/-40°	2	4	2		900X2180X2020	1700X2750X2300	1300	5400	10,3
	PLUS											15000	24,2
GC602	STD	1050	720	+85°/-40°	2	6	3		900X3280X2020	1700X3850X2300	1950	7935	14,7
	PLUS											22335	35,6
GC802	STD	1400	960	+85°/-40°	2	8	4		900X4380X2020	1700X4950X2300	2600	10470	19,2
	PLUS											29670	47,0
GCR201	STD	170	120	+85°/-40°	1	1	-		700X940X1700	1500X1330X2230	410	795	2,1
	PLUS											5595	9,1
GCR202	STD	220	150	+85°/-40°	1	-	1		900X1140X1700	1700X1530X2230	570	795	2,1
	PLUS											5595	9,1

GN 1

GN 2

GN R





POLARIS ALI GROUP SRL  
Via Cav. Vittorio Veneto, 25  
32036 Sedico - BL - I

**polarisprofessional.com**

**Art Direction:** Ateikon Internet & Multimedia srl  
**All right reserved.**  
**Print:** Sincromia srl  
**Edition:** 3/2021

**Note**

Le fotografie dei prodotti e i campioni dati al cliente hanno valore puramente indicativo e pubblicitario. Il cliente non potrà fondare alcun reclamo su eventuali differenze tra la merce fornita e quanto risulta dal materiale dimostrativo in suo possesso.

La Polaris Ali group srl si riserva inoltre la facoltà di apportare ai propri prodotti le migliorie di carattere tecnico e costruttivo che riterrà opportune, in qualsiasi momento.

**Notes**

*The photos of the products and the samples given to the customer have only indicative and advertising value. The customer cannot found any claim on any differences between the supplied goods and the demonstrative samples in their possession.*

*Moreover Polaris Ali group srl reserves the right to make technical, constructive or design changes at any time and without prior notice.*